



Construction of tomorrow

Emission free, efficient,
reliable



Electric driven & regulated speed screw compressors

Elec50

Emission free, efficient, reliable

Elec50 – electric driven & speed regulated

CompAir's range of portable compressors have proven their reliability and efficiency in the toughest of environments. The new **Elec50** compressors combine these characteristics with the benefits of an emission-free, extremely quiet and economic electric drive:

The **Elec50** is ideal for use in environmental or noise protection zones, e.g. in tunnels, narrow excavations and inside buildings. Wherever a power supply is available, the compressor can be connected on the public power grid.

Compared to a diesel equivalent, the **Elec50** offers potential **savings of 46 % in energy costs** and **36 % in maintenance and servicing costs**.

For more information – click here:



[Video Elec50](#)



Typical applications

- ▶ Pickhammers and Breakers
- ▶ Blow-out work
- ▶ Drilling
- ▶ Displacement hammers
- ▶ Spray painting
- ▶ Sand and ice blasting
- ▶ Environmental or noise protection zones
- ▶ Urban or indoor applications as in tunnels, narrow excavation pits or buildings



Features & benefits



Working pressure
5 to 12 bar



New **DELCO**
Controller and **iConn**
for GPS tracking



Mobile 5 warranty up
to **5 years protection**
for your investment



Volume flow
3,5 m³/min at 12 bar
5,0 m³/min up to 7 bar



AirPlus – the **right**
compressed air
for your application



German engineering,
design & manufacture



Motor power
30 kW



Service kits for
cost-effective
maintenance



Health protection
for employees



Cross weight (unbraked):
< 750 kg – can be **towed**
by passenger car



60% known main com-
ponents ensure a **good**
spare parts supply



For **urban** construction
sites or **indoor** applications



FPM – Flexible Power
Management with
16A to 63A



Up to **46% savings** in
energy costs and **36%**
savings in maintenance
and **servicing costs** com-
pared to a diesel equivalent



Plug & Play on the
public power grid



Regulated speed
screw compressors



Elec50



Options – AirPlus

(Aftercooler is standard)



- ▶ Bypass-Aftercooler (On/Off)
- ▶ Bypass-Heat-Exchanger (On/Off)
- ▶ Fine Filter
- ▶ Hose Recoiler
- ▶ Tool Lubrication
- ▶ Control Air Lubrication

- ▶ Adapter Cable 63A/32A
- ▶ Adapter Cable 32A/16A
- ▶ IE4-Engine
- ▶ iConn

- ▶ Chassis options:
 - height adjustable, braked
 - height adjustable, unbraked
 - straight towbar, braked
 - straight towbar, unbraked
 - skid/base frame
 - without skid/base frame/chassis

For more information – click here:



[Video Elec50](#)

Click here:

[Submit a request](#)



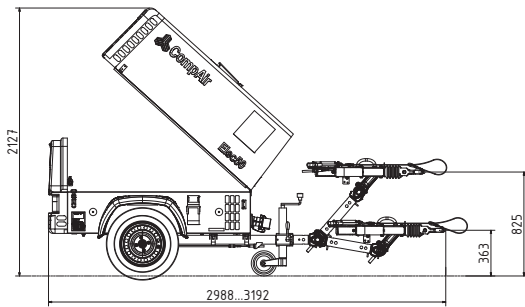

height adjustable, braked

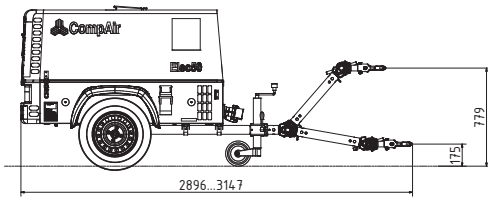

height adjustable, unbraked

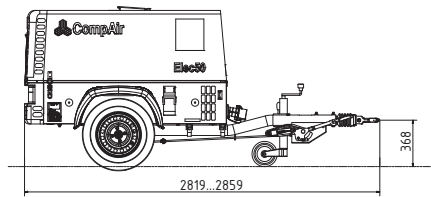

straight towbar, braked

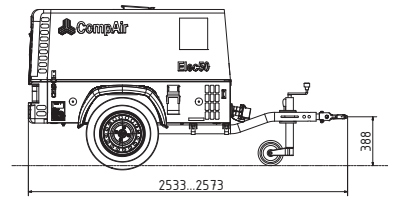

straight towbar, unbraked

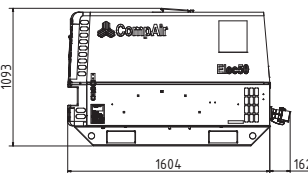
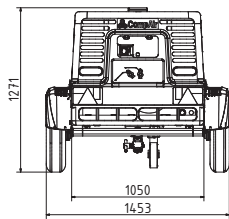

skid/base frame

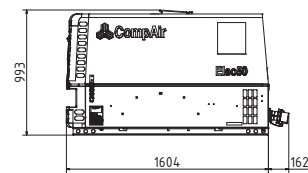

without skid/base frame/chassis

Technical data

Series	DLT0501		
Type	Elec50		
	Flexible Power Management		
Volume flow at operating overpressure ¹⁾	m ³ /min	3,5 at 12 bar 5,0 up to 7 bar	
Operating overpressure	bar	5 – 12	
Engine	IP55 (IE-3) – IEC 60034-2-1 ECA Qualifying		
Nominal voltage	V/Hz [tolerance voltage]	400 / 50 [± 10 %]	
Electrical connection	63A CEE-Plug 6h		
Emission standard	emissionfree		
Installed engine power	kW	30,0	
Idle speed – full speed	1/min	800 – 4250	
Operating weight ^{2), 3)}	– height adjustable, braked	kg	781
	– height adjustable, unbraked	kg	745
	– straight towbar, braked	kg	754
	– straight towbar, unbraked	kg	725
Dimensions LxWxH	– adjustable, braked	mm	2988–3192 x 1456 x 1250
	– straight, braked	mm	2859 x 1456 x 1250
Compressed air connections	2 x 3/4"		
Sound pressure level ⁴⁾	dB(A) LPA	69	

¹⁾ According to ISO 1217 Ed. 4 2009 Annex D

²⁾ Operating weight with operating materials, without options

³⁾ All models are available with skid-base frame or without skid/base frame/chassis ⁴⁾ Sound pressure level according to PNEUROP PN8NTC.2.2 at 7 m

Global experience — truly local service



With over 200 years of engineering excellence, the CompAir brand offers an extensive range of highly reliable, energy efficient compressors and accessories to suit all applications. An extensive network of dedicated CompAir sales companies and distributors across all continents provide global expertise with a truly local service, ensuring our advanced technology is backed up with the right support.

Portable Compressors (EU & Non EU Range)

- Petrol or diesel driven C14-12 – C270TS-9
1,0 to 27,0 m³/min; 7 to 24 bar
- Electric driven Elec50
3,5 m³/min at 12,0 bar / 5,0 m³/min up to 7,0 bar

AirPlus offers many variations and options:

- Aftercooler
- Ultra-fine filters
- Integrated generator
- Bunded bottom box
- Hose reel
- Chalwyn Valve
- Exhaust spark arrestor
- Exhaust gas particulate filter
- Customer colours

Tools:

- Chipping Hammers
- Rockdrills
- Pickhammers
- Breakers

Vibration damped tools:

- Rockdrills
- Pickhammers
- Breakers

Accessories:

- Large selection of pointed chisel, slat chisel and spade
- In line lubricator
- Water separator with or without oiler
- Air hoses

Service

- Technical support and advice
- Worldwide service network
- Reliable supply of spare parts
- Individual customer solutions
- Seminars and trainings



Contact Granzow A/S



www.granzow.dk
(+45) 4320 2600
Info@granzow.dk

GRANZOW ^A/_S

INDUSTRIAL SOLUTIONS since 1935